

TOLERANCE	TAPE MEASURE ±1/16"	CALIPER ±.010"	DRAWING APPROVED	BOM ENTERED	ALLOY
OVERRIDDEN					COMMENTS

REV	NOTES
-----	-------

A
B
C
D
E
F
G
H

A
B
C
D
E
F
G
H

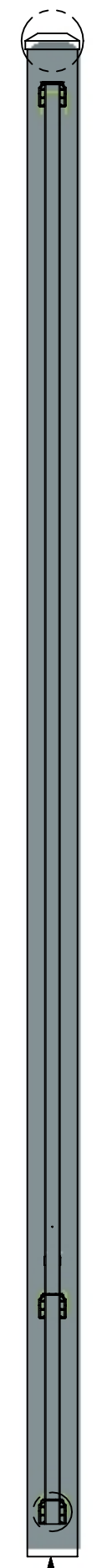
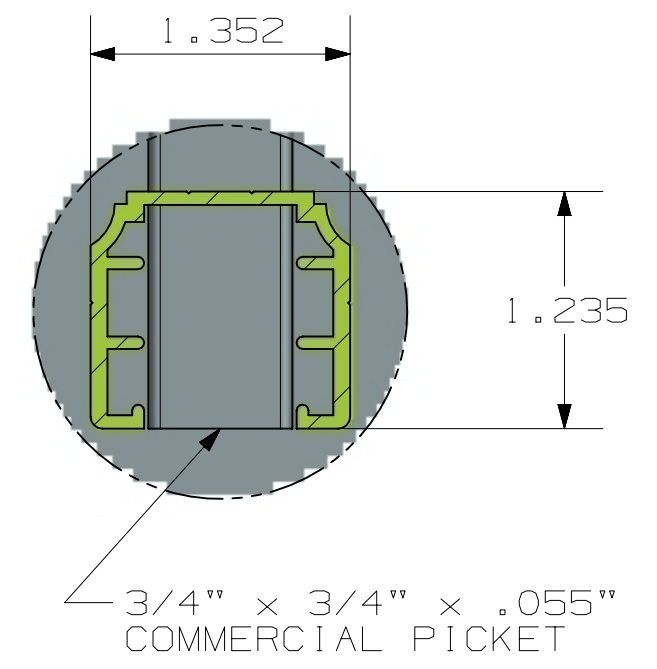
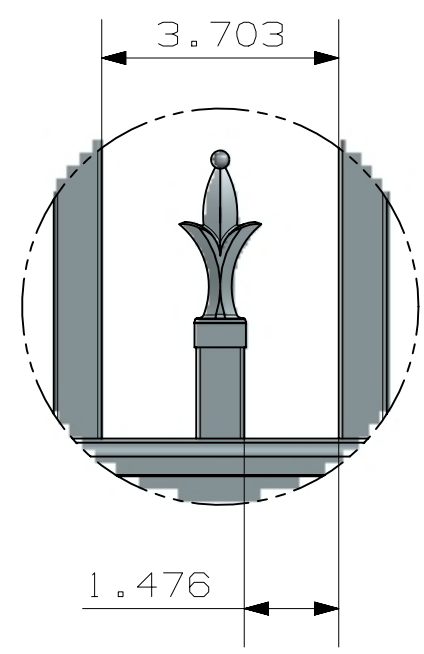
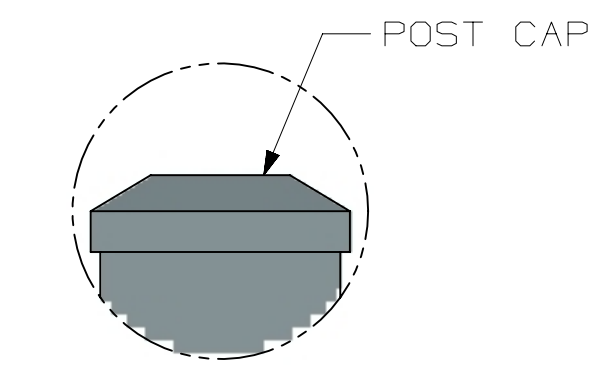

M

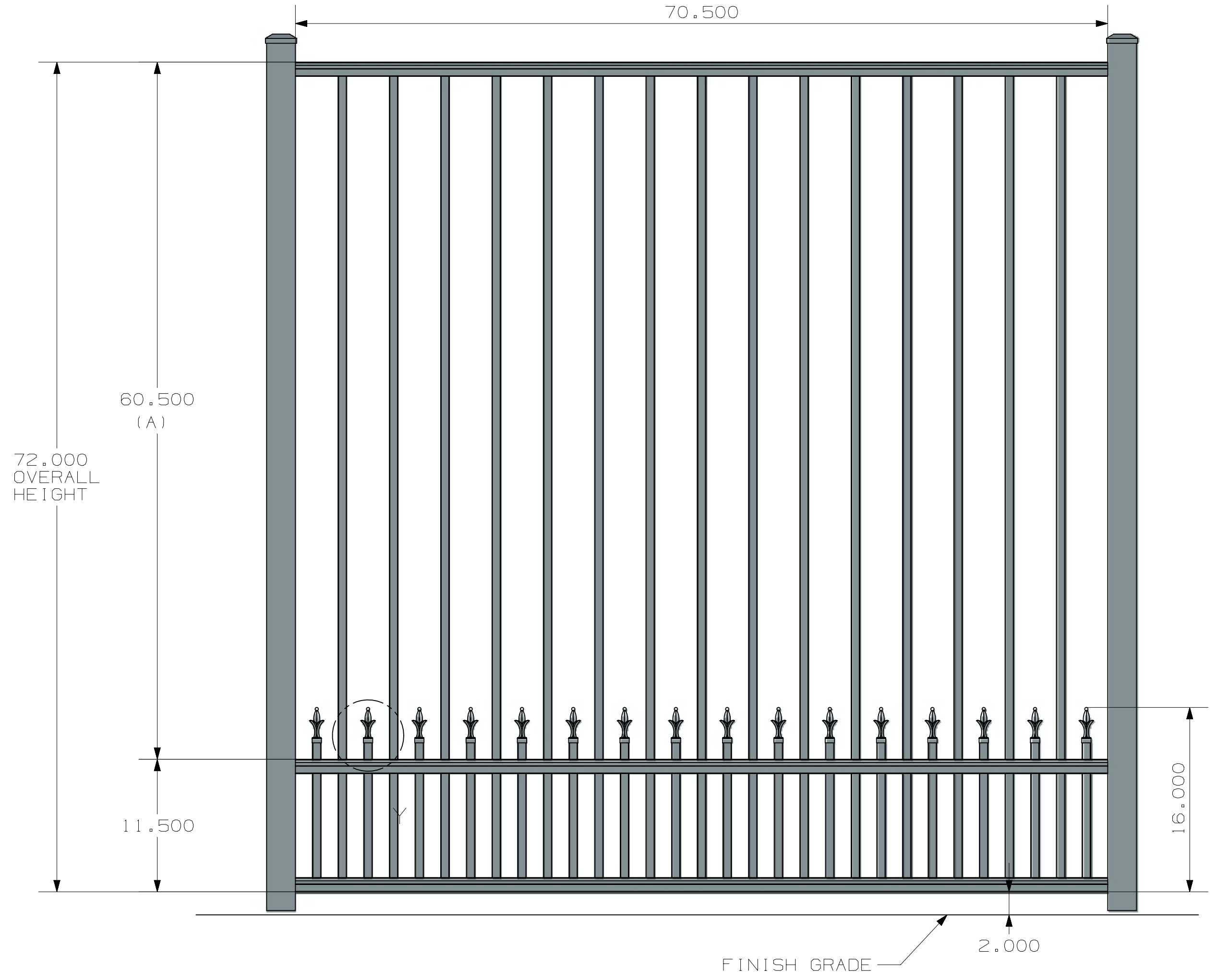

- POST OPTIONS
- 2" X 2" X .080" WALL
 - 2" X 2" X .125" WALL
 - 2 1/2" X 2 1/2" X .100" WALL
 - 3" X 3" X .125" WALL

4 RAIL HEIGHT	
HEIGHT	A
3'	24.5"
3 1/2'	30.5"
4'	36.5"
4 1/2'	42.5"
5'	48.5"
6'	60.5"

INSIDE OF POST WIDTH	
NOMINAL	ACTUAL
4'	46.5"
6'	70.5"
8'	94.5"

ULTRA ALUMINUM MANUFACTURING, INC
2124 GRAND COMMERCE DR. HOWELL, MI 48855
PHONE (800) 656-4420 FAX (800) 643-7426

	DATE	11-28-2023
	REV	2
	SHEET	1 OF 1

COMMERCIAL
UAF-200 FLAT TOP
FLUSH BOTTOM
SHORT TRI
3-RAIL

UAF-200 FLAT TOP FLUSH BOTTOM COMMERCIAL 6X6 SHORT TRI 3 RAIL