

TOLERANCE	TAPE MEASURE ±1/16"	CALIPER ±.010"	DRAWING APPROVED	BOM ENTERED	ALLOY
OVERRIDDEN					COMMENTS

REV	NOTES
-----	-------

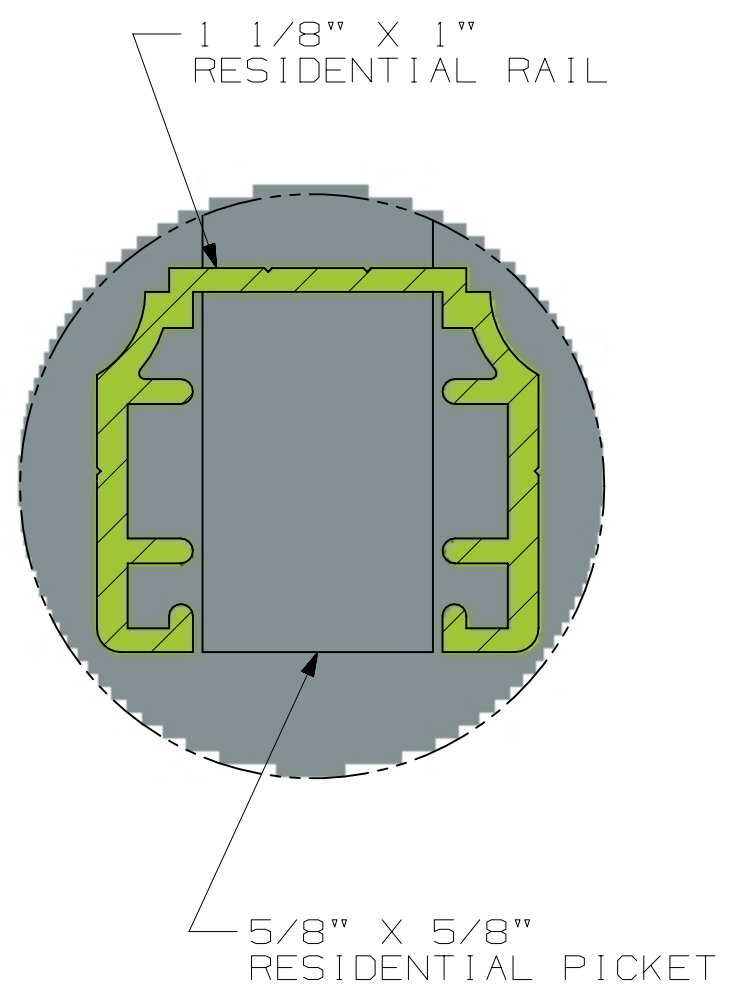
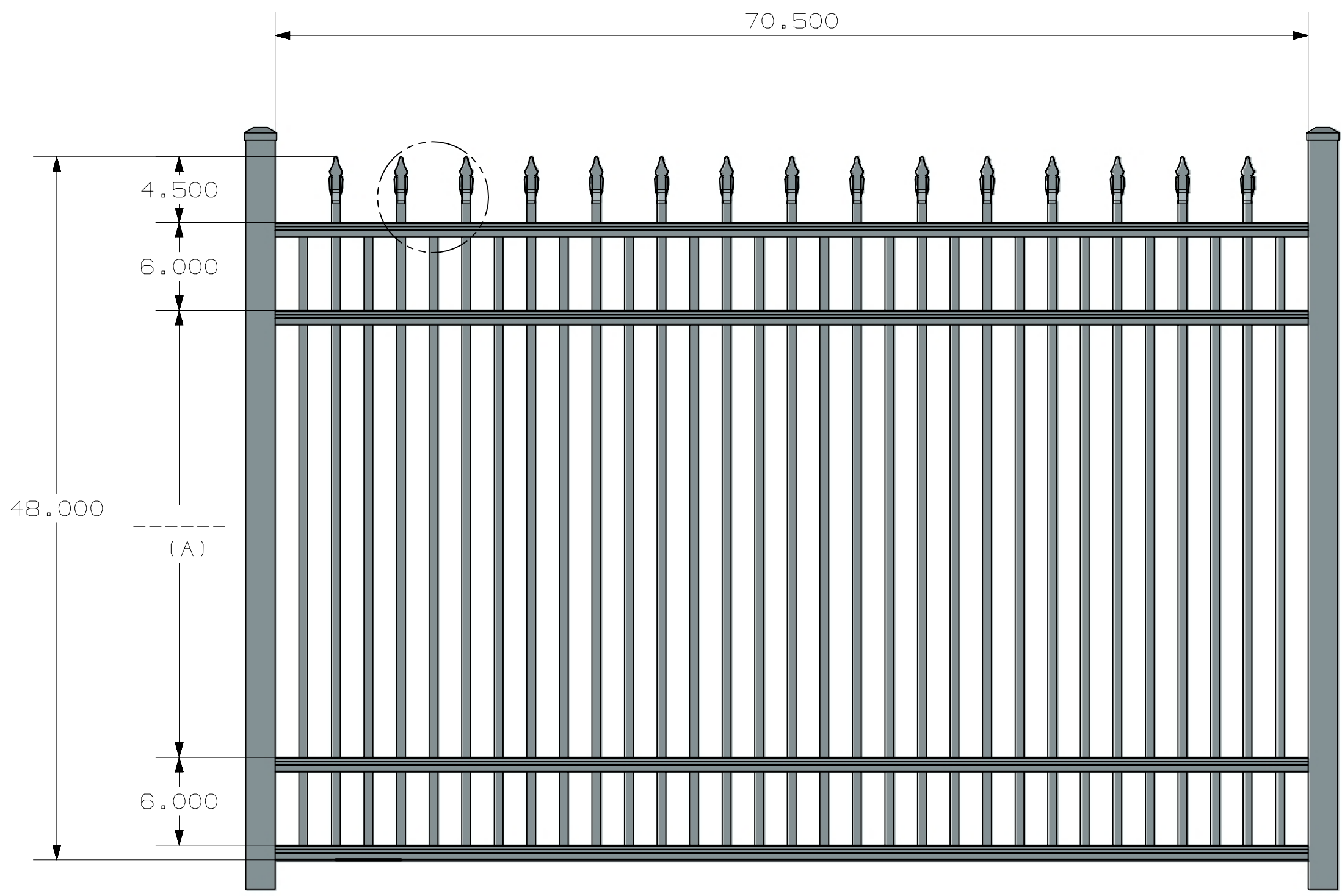
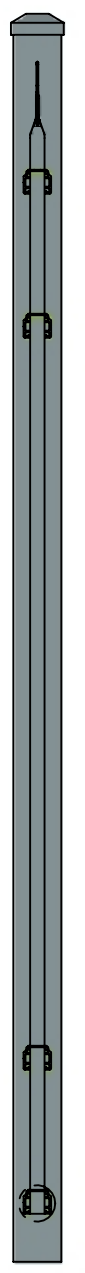
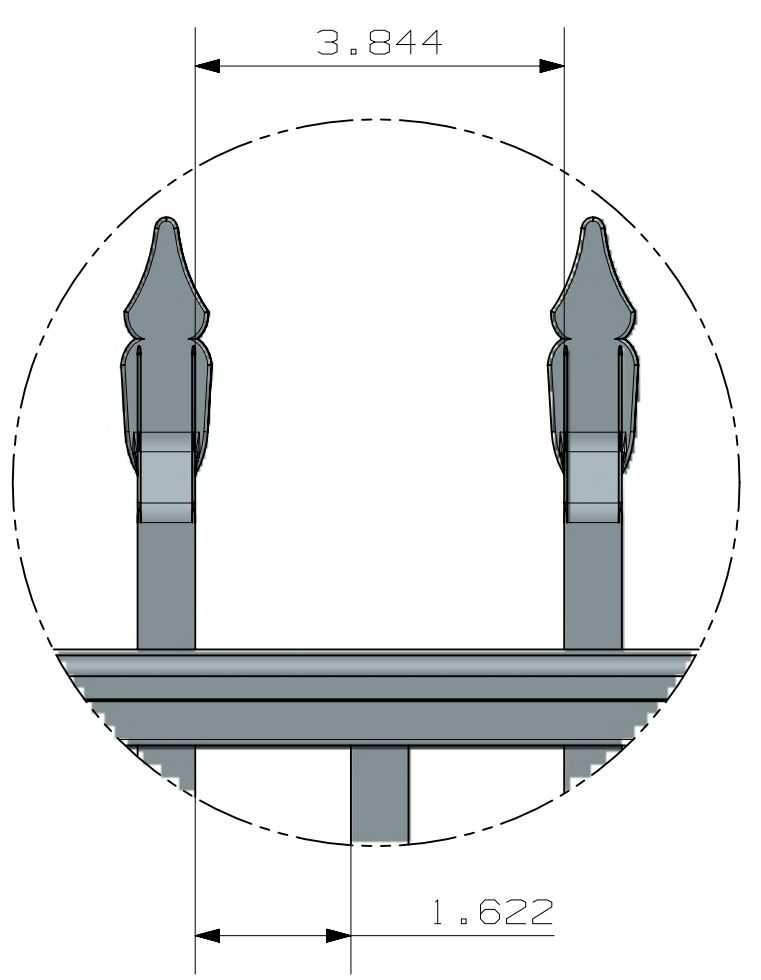

HEIGHT	(A)
3'	18 1/2"
3 1/2'	24 1/2"
4'	30 1/2"
4 1/2'	36 1/2"
5'	42 1/2"
6'	54 1/2"

INSIDE OF POST WIDTH	
NOMINAL	ACTUAL
5'	61.6875"
6'	70.5"
7'	83.875"

ULTRA ALUMINUM MANUFACTURING, INC
 2124 GRAND COMMERCE DR. HOWELL, MI 48855
 PHONE (800) 656-4420 FAX (800) 643-7426

	DATE	12-15-2023
	REV	1
	SHEET	1 OF 1

RESIDENTIAL
 UAS - 101 SPEAR TOP
 FLUSH BOTTOM
 4 - RAIL

UAS-101 SPEAR TOP FLUSH BOTTOM RESIDENTIAL 6X4 4-RAIL