

TOLERANCE	TAPE MEASURE ±1/16"	CALIPER ±.010"	DRAWING APPROVED	BOM ENTERED	ALLOY
OVERRIDDEN					COMMENTS

REV	NOTES
-----	-------

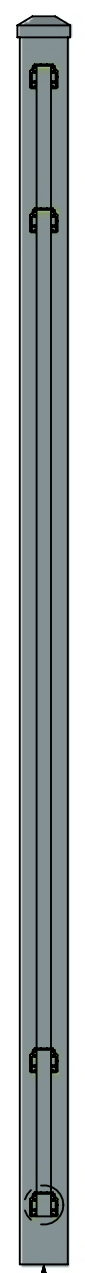

- POST OPTIONS
- 2" x 2" x .060" WALL
 - 2" x 2" x .080" WALL
 - 2" x 2" x .125" WALL
 - 2 1/2" x 2 1/2" x .100" WALL

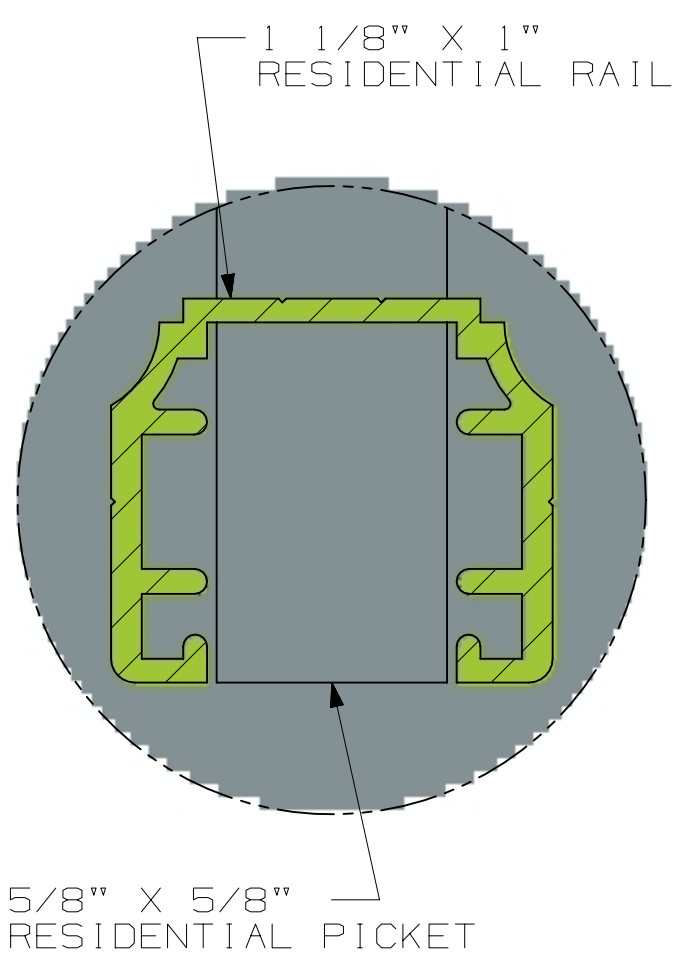
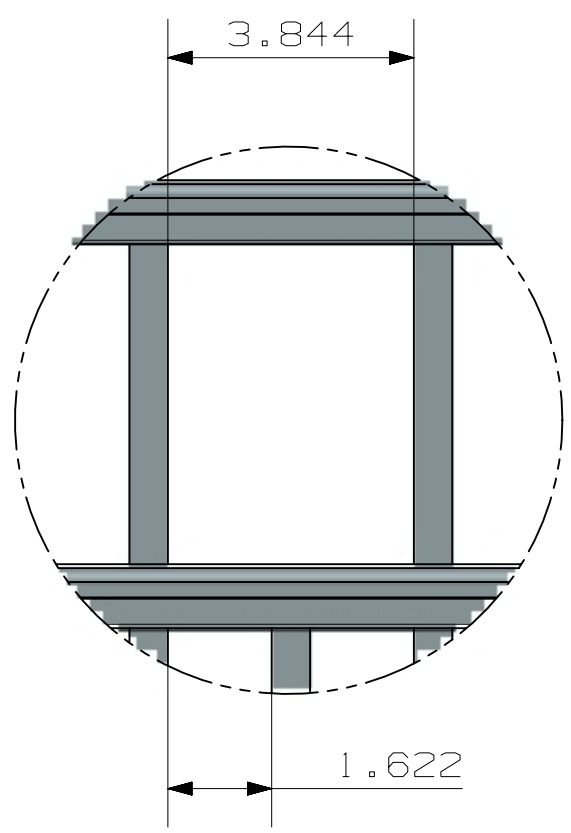
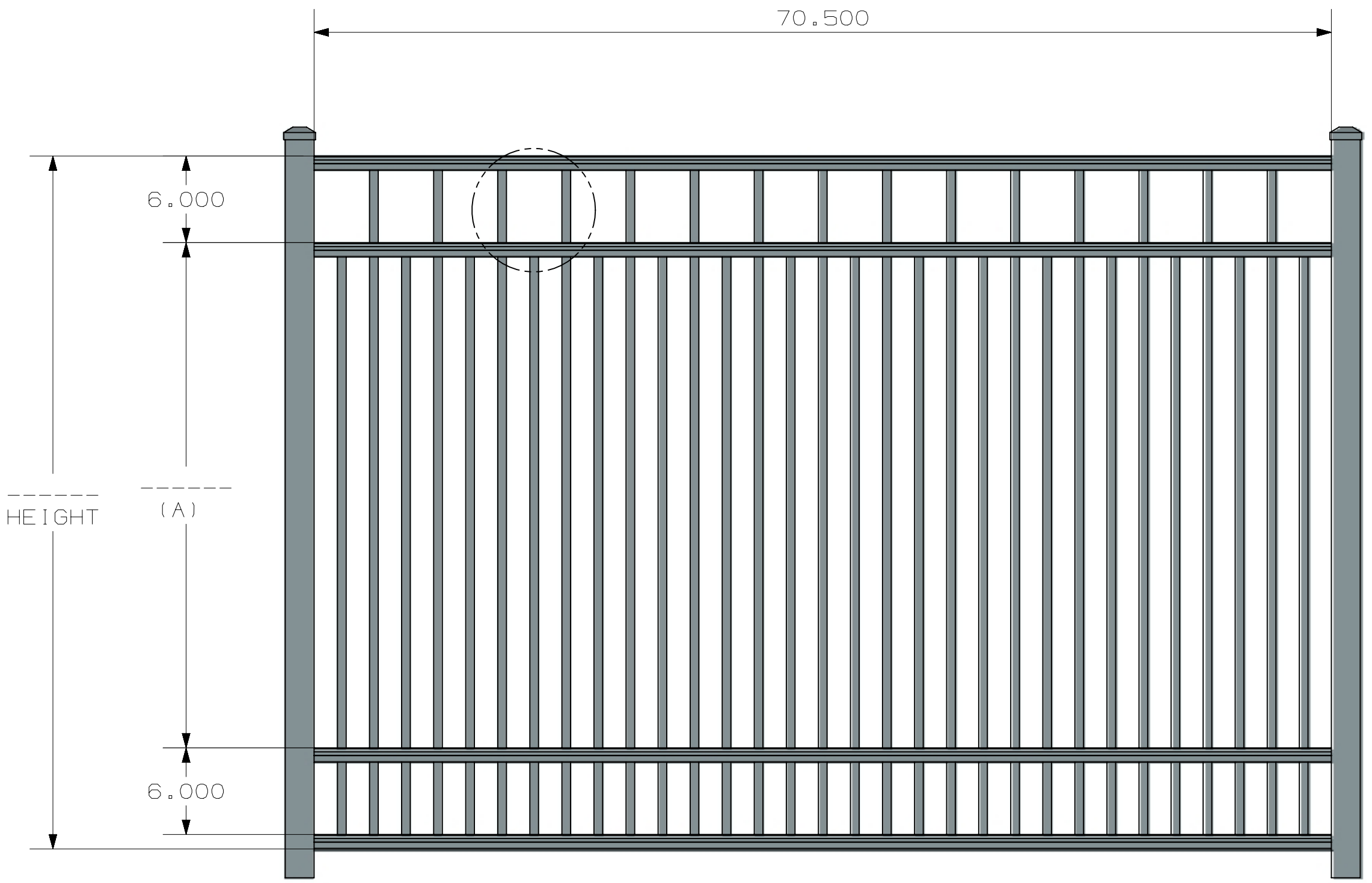

HEIGHT	(A)
3'	23"
3 1/2'	29"
4'	35"
4 1/2'	41"
5'	47"
6'	59"

INSIDE OF POST WIDTH	
NOMINAL	ACTUAL
5'	61.6875"
6'	70.5"
7'	83.875"

ULTRA ALUMINUM MANUFACTURING, INC
 2124 GRAND COMMERCE DR. HOWELL, MI 48855
 PHONE (800) 656-4420 □ FAX (800) 643-7426

	DATE	12-12-2023
	REV	1
	SHEET	1 OF 1

RESIDENTIAL
 UAF - 201 FLAT TOP
 FLUSH BOTTOM
 4 - RAIL

UAF-201 FLAT TOP FLUSH BOTTOM RESIDENTIAL 6X4 4 RAIL