

TOLERANCE	TAPE MEASURE ±1/16"	CALIPER ±.010"	DRAWING APPROVED	BOM ENTERED	ALLOY
OVERRIDDEN					COMMENTS

REV	NOTES
-----	-------

A
B
C
D
E
F
G
H

A
B
C
D
E
F
G
H

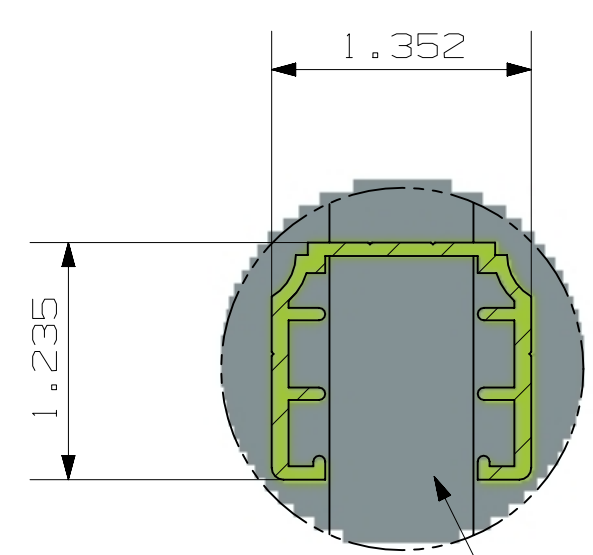
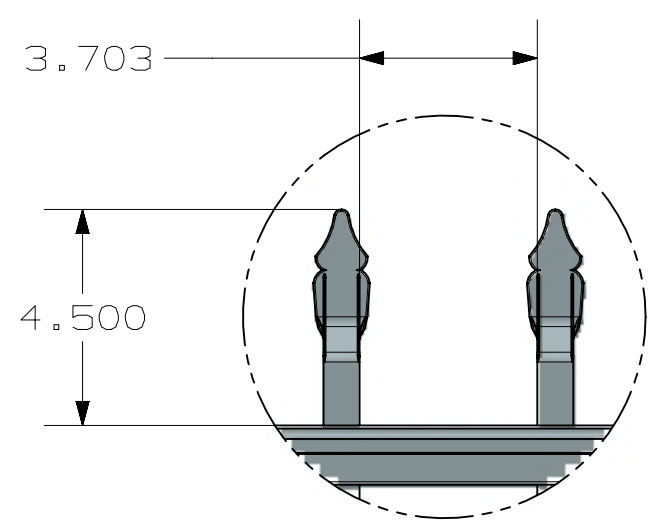
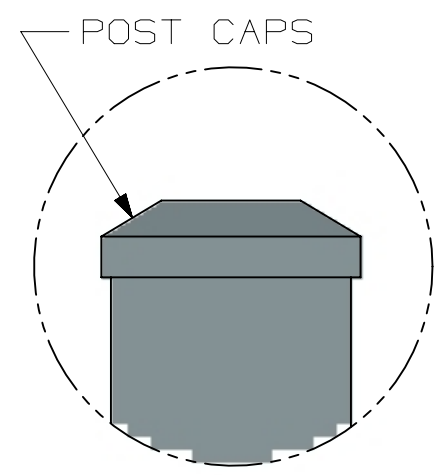

3/4" x 3/4" x .055"
COMMERCIAL PICKET

POST OPTIONS
 2" X 2" X .080 WALL
 2" X 2" X .125 WALL
 2.5" X 2.5" X .100 WALL
 3" X 3" X .125 WALL

HEIGHT	A
3'	20"
3 1/2'	26"
4'	32"
4 1/2'	38"
5'	44"
6'	56"

INSIDE OF POST WIDTH	
NOMINAL	ACTUAL
4'	46.5"
6'	70.5"
8'	94.5"

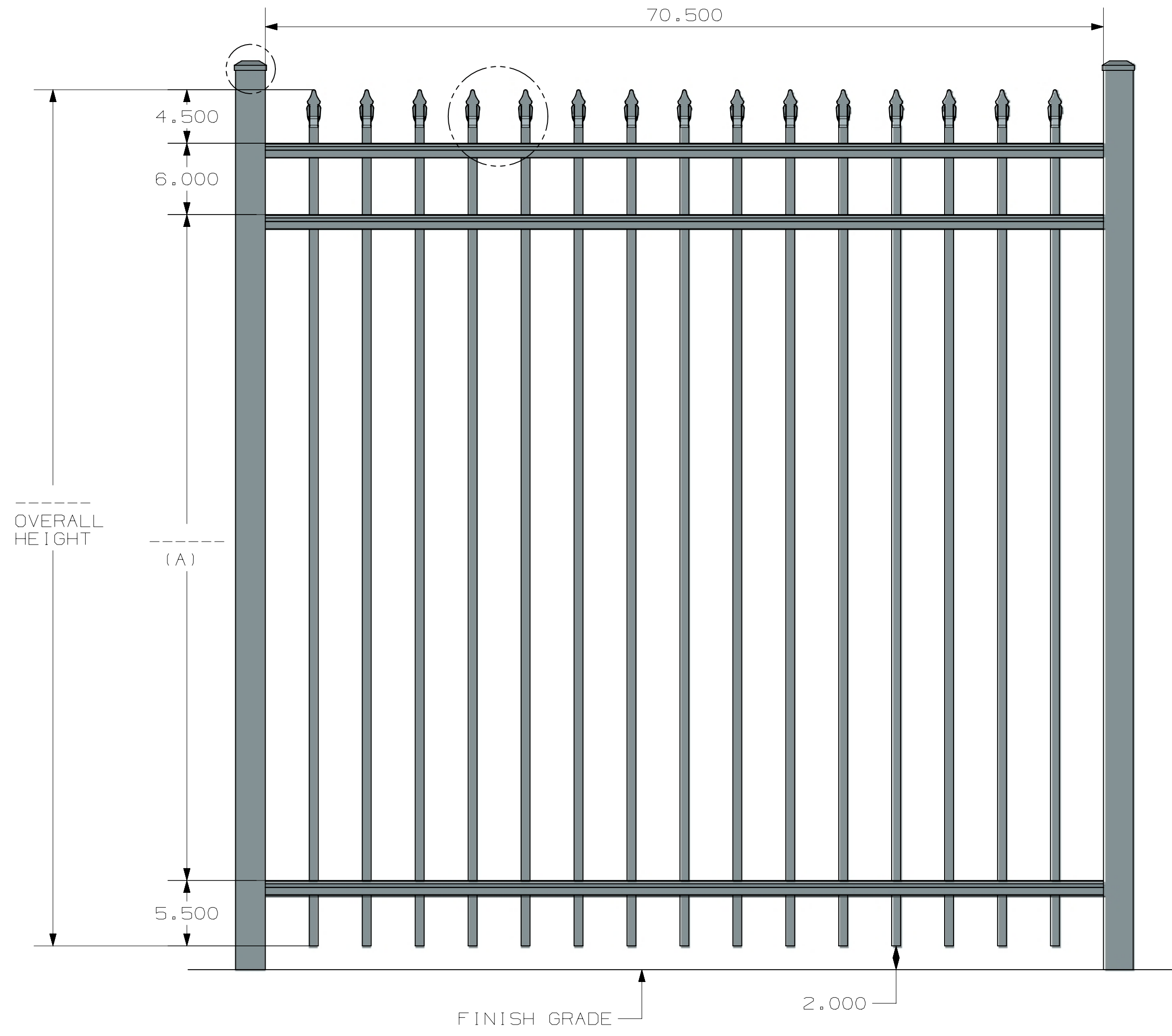
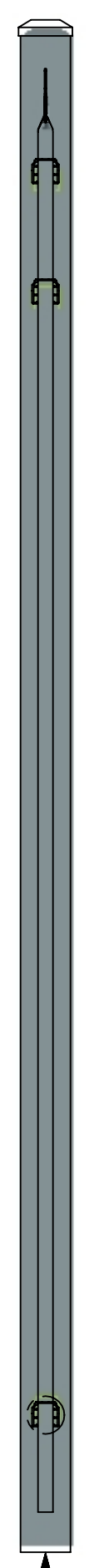

ULTRA ALUMINUM MANUFACTURING, INC
 2124 GRAND COMMERCE DR. HOWELL, MI 48855
 PHONE (800) 656-4420 FAX (800) 643-7426

	DATE	12-5-2023
	REV	1
	SHEET	1 OF 1

UAF-100 SPEAR TOP
 STD BOTTOM
 COMMERCIAL SHOP DRAWING
 3-RAIL

UAS-100 STD BOTTOM COMMERCIAL SPEAR TOP 6X6 3 RAIL