

TOLERANCE	TAPE MEASURE ±1/16"	CALIPER ±.010"	DRAWING APPROVED	BOM ENTERED	ALLOY
OVERRIDDEN					COMMENTS

REV	NOTES
-----	-------

A
B
C
D
E
F
G
H

A
B
C
D
E
F
G
H

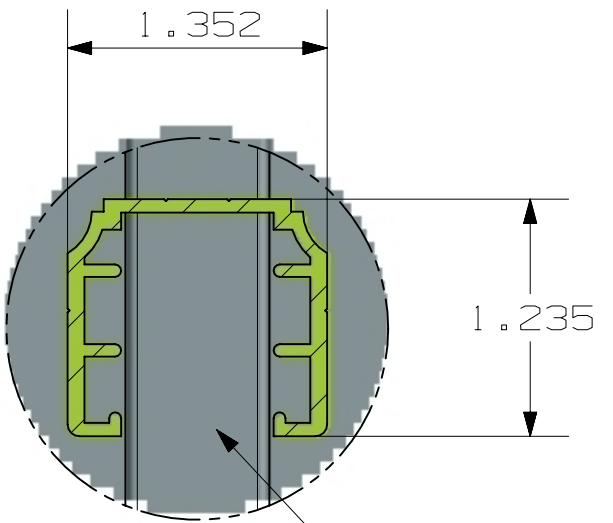
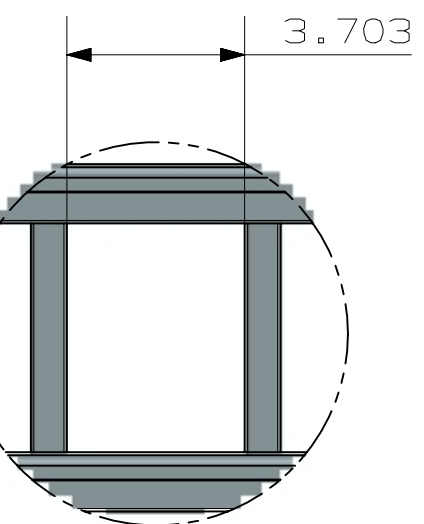
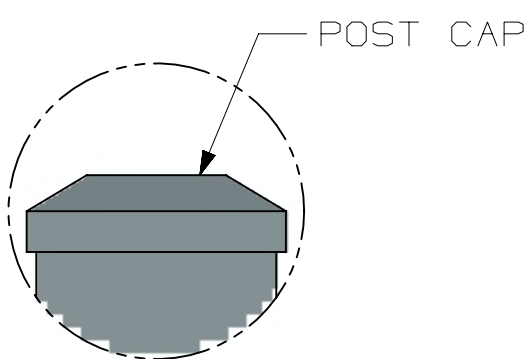

3/4" x 3/4" x .055" COMMERCIAL PICKET

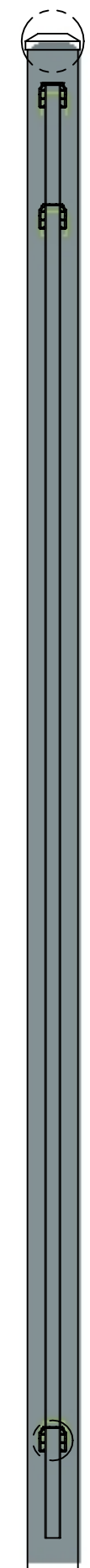

X

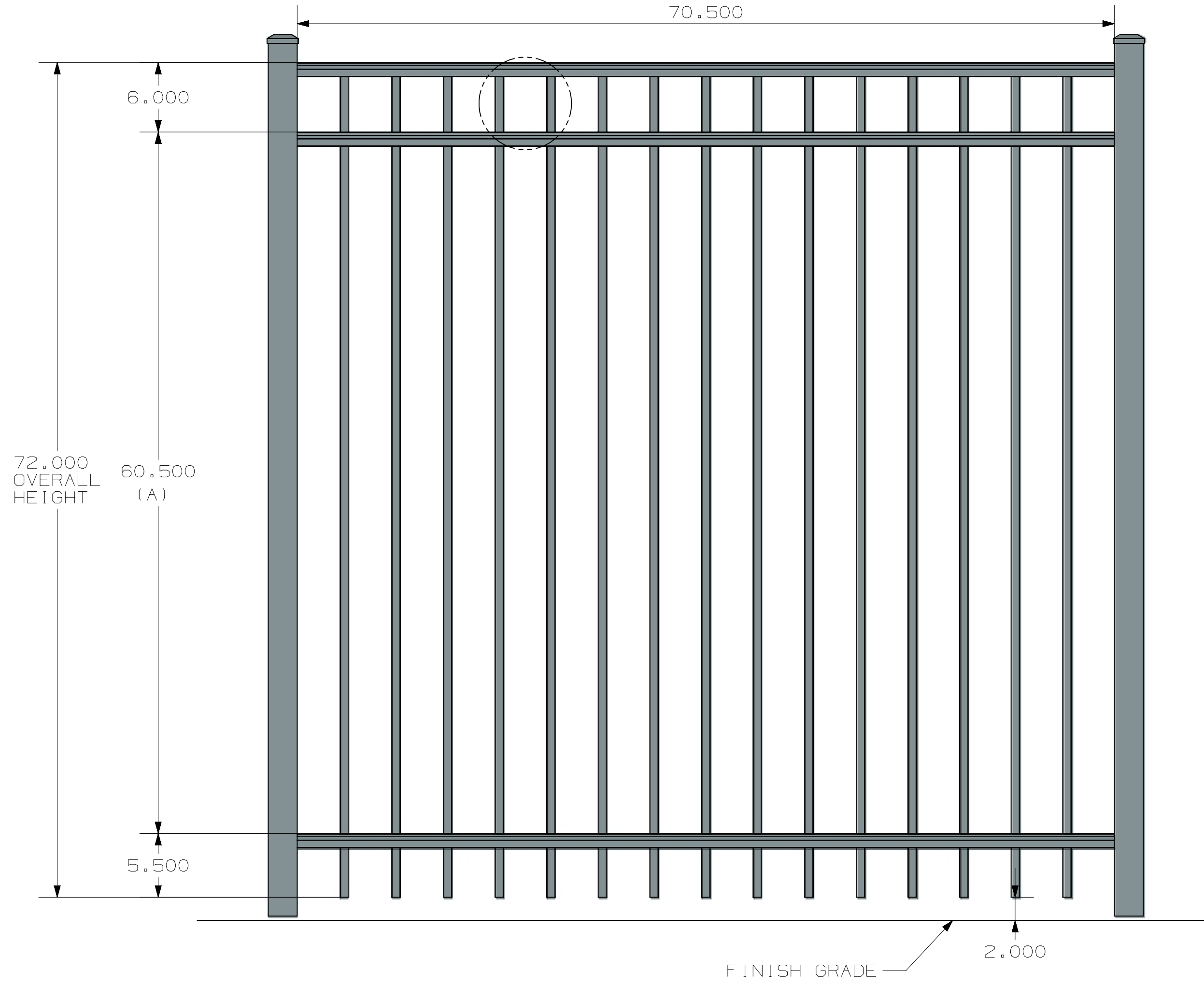

- POST OPTIONS
- 2" X 2" X .080" WALL
 - 2" X 2" X .125" WALL
 - 2 1/2" X 2 1/2" X .100" WALL
 - 3" X 3" X .125" WALL

4 RAIL HEIGHT	
HEIGHT	A
3'	24 1/2"
3 1/2'	30 1/2"
4'	36 1/2"
4 1/2'	42 1/2"
5'	48 1/2"
6'	60 1/2"

INSIDE OF POST WIDTH	
NOMINAL	ACTUAL
4'	46.5"
6'	70.5"
8'	94.5"

ULTRA ALUMINUM MANUFACTURING, INC
2124 GRAND COMMERCE DR. HOWELL, MI 48855
PHONE (800) 656-4420 FAX (800) 643-7426

	DATE	11-28-2023
	REV	2
	SHEET	1 OF 1

COMMERCIAL
UAF-200 FLAT TOP
STD BOTTOM
3-RAIL

UAF-200 FLAT TOP STD BOTTOM COMMERCIAL 6X6 3 RAIL